



## Mechanical Workshop

S.No.	Item Name	Model	Manufacturer	Usage	Picture
1	Optimum – o PTIS 181 G sawing Machine Code No. 3300182 Germany	o PTIS 181 G	Optimum – Maschinen-GMBH	<ul style="list-style-type: none"> <li>metal sawing</li> </ul>	

2	Shaping machine Model B6050 Serial No. 4503812 Almusairey industrial Equipment Co Info@ almusairey.com KSA	B6050	N/A	<ul style="list-style-type: none"> <li>metal shaping</li> </ul>	
---	--	-------	-----	---	---



3	Lunan BD – 1340 Lathe Machine Model LC 340A	LC 340A	Lunan	<ul style="list-style-type: none"><li>• turning operations</li></ul>	
---	---	---------	-------	--	---

4	Lathe Machine TP 125X500	TP 125X500	Predit	<ul style="list-style-type: none"> <li>• for making turning operations like threading, facing, taper turning, holes , cutting off,...etc</li> </ul>	
---	-----------------------------	---------------	--------	---	---



5	Optimum – Maschinen- Germany Vertical Milling Machine	N/A	Optimum – Maschinen- GMBH	• Vertical milling operations	
---	--	-----	---------------------------------	----------------------------------	--

6	Optimum – Maschinen- GMBH Hallstadt- Germany Radial Bench drilling Machine OPT1 RB 35	OPT1 RB 35 Code No. 3335035	Optimum – Maschinen- GMBH	• drilling operations	
---	---	--------------------------------------	---------------------------------	--------------------------	---

7	Vertical surface grinding Machine Ref- MA 0909/ E10/ 006A Predit	MA 0909/ E10/ 006A	Predit	• grinding operations	
---	--	-----------------------	--------	-----------------------	--

8	Sand Casting	N/A		<ul style="list-style-type: none"> <li>• sand casting</li> </ul>	
9	Spot welding	modular 230 194582/09	TELWIN	For joining sheet metals together	



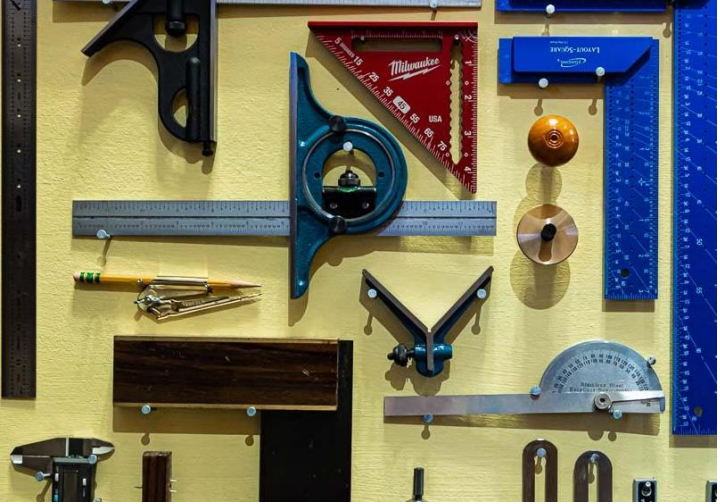

10	Desktop rolling machine	BIRLIK TYPE B.K	BIRLIK	for redusing the thickness of materials	
11	Bench shear	N/A	N/A	shearing operation	

12	Manual jenny	N/A	N/A	Manual jenny	
13	Bench work tools(micrometers, Vernier calipers, files, chisels, center punches, Rules, Set squares, Taps and dies, dial guage, V-block, Scriber, Cutting tools, Hacksaw, screw drivers, Spanners, Allan keys, Pliers, goggles, gloves and hammers, 2	N/A	N/A	Bench work	

	anvils, 3 vices, hand drill, )				
14	Bench drill	N/A	NV TOOL POWER	Bench drilling	

15	Amaco select fire oven	EX – 1099SF	Amaco	heat treatment/casting	
----	------------------------	-------------	-------	------------------------	---

16	Drills (total No. 4) TB – 16	TB – 16	N/A	drilling operations	
17	Drill bit grinder	optimum D G 20	Optimum – Maschinen- GMBH	Drill bit grinder	

18	hydraulic forging press		Anyang	Metal forging	
----	-------------------------	--	--------	---------------	---